

Article number: 604144056050

Description: Timing belt pulley with hub
HTD 56 8M 50

Measures

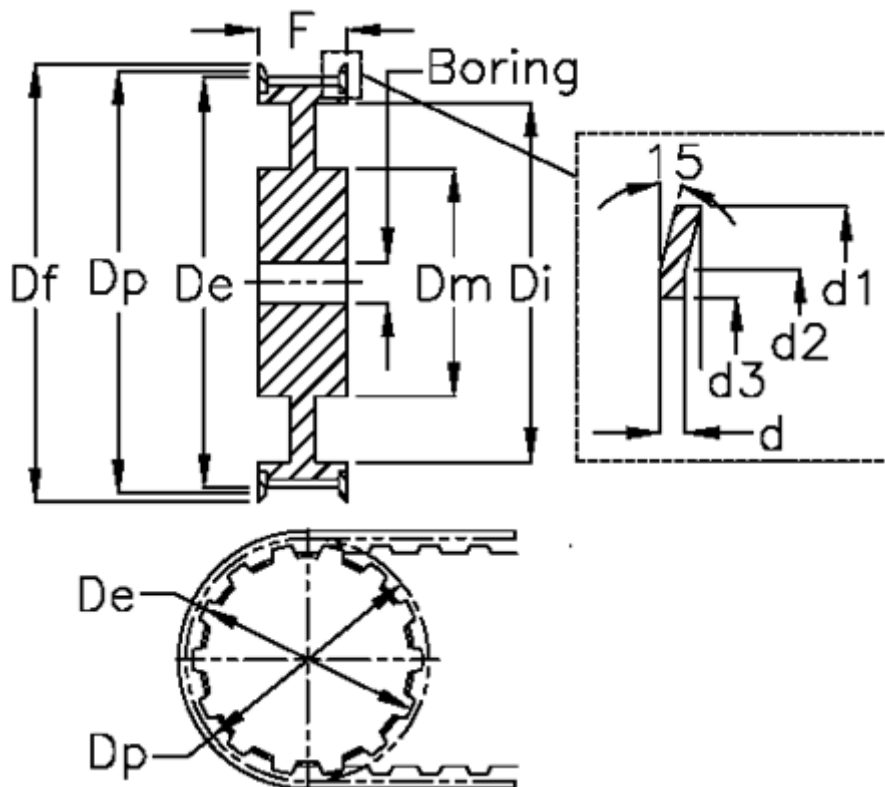

Bore = 18	Dm = 90	Width = 50
d = 1.5	Dp = 142.6	
d1 = 150	F = 116	
d2 = 145	Flange type = F48	
d3 = 130	L = 60	
De = 141.23	Tooth number = 56	
Df = 150	Type = 8M	
Di = 60	Weight = 5	